

## J-Line™ Interconnection Systems

30–200/270 Amp (30–200A Load Breaking), Maximum 600VAC/250VDC  
Load-Breaking Receptacles, Plugs, Connectors and Inlets

### Plugs and Connectors

Watertight Male — Plug

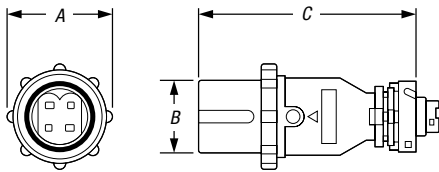

Female — Connector

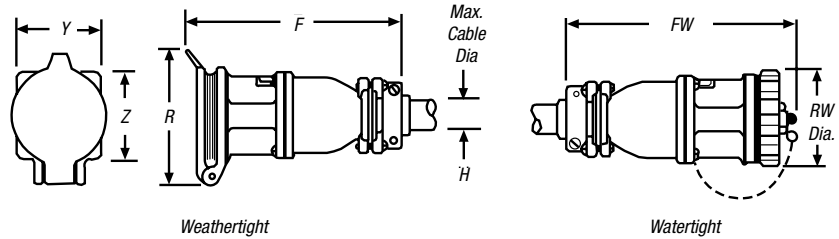

#### Dimensions for 2-, 3- or 4-Wire Weathertight and Watertight Units

AMP	A	B	C	WEATHERTIGHT		WATERTIGHT		Y	Z	H
				F	FW	R	RW			
30	3"	2 <sup>1</sup> / <sub>8</sub> "	7"	8 <sup>1</sup> / <sub>8</sub> "	8 <sup>3</sup> / <sub>8</sub> "	4 <sup>1</sup> / <sub>4</sub> "	3"	2 <sup>3</sup> / <sub>4</sub> "	2 <sup>3</sup> / <sub>4</sub> "	1
60	3 <sup>3</sup> / <sub>4</sub> "	2 <sup>9</sup> / <sub>16</sub> "	8 <sup>7</sup> / <sub>8</sub> "	10 <sup>3</sup> / <sub>4</sub> "	10 <sup>9</sup> / <sub>16</sub> "	5"	3 <sup>3</sup> / <sub>4</sub> "	3 <sup>1</sup> / <sub>2</sub> "	3 <sup>1</sup> / <sub>2</sub> "	3 <sup>3</sup> / <sub>8</sub> "
100/150	4 <sup>1</sup> / <sub>8</sub> "	2 <sup>9</sup> / <sub>16</sub> "	10 <sup>1</sup> / <sub>4</sub> "	10 <sup>1</sup> / <sub>2</sub> "	10 <sup>7</sup> / <sub>16</sub> "	5 <sup>1</sup> / <sub>4</sub> "	4 <sup>1</sup> / <sub>8</sub> "	4"	4"	1 <sup>7</sup> / <sub>8</sub> "
200/270	5 <sup>1</sup> / <sub>4</sub> "	3 <sup>1</sup> / <sub>16</sub> "	14 <sup>1</sup> / <sub>8</sub> "	14 <sup>1</sup> / <sub>8</sub> "	15 <sup>3</sup> / <sub>8</sub> "	7 <sup>1</sup> / <sub>8</sub> "	5 <sup>1</sup> / <sub>4</sub> "	5 <sup>1</sup> / <sub>8</sub> "	5 <sup>1</sup> / <sub>8</sub> "	2 <sup>1</sup> / <sub>2</sub> "

### Basic Receptacles

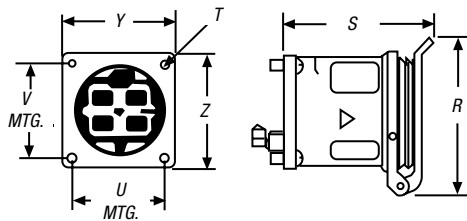

#### Dimensions for 2-, 3- or 4-Wire Units

AMP	Z	Y	X	WEATHERTIGHT		WATERTIGHT		V	U	T
				S	SW	R	RW			
30	2 <sup>3</sup> / <sub>4</sub> "	2 <sup>3</sup> / <sub>4</sub> "	1	3 <sup>3</sup> / <sub>8</sub> "	3 <sup>3</sup> / <sub>4</sub> "	4 <sup>1</sup> / <sub>4</sub> "	3"	2 <sup>1</sup> / <sub>4</sub> "	2 <sup>1</sup> / <sub>4</sub> "	1 <sup>1</sup> / <sub>4</sub> "
60	3 <sup>1</sup> / <sub>2</sub> "	3 <sup>1</sup> / <sub>2</sub> "	1 <sup>1</sup> / <sub>4</sub> "	4 <sup>5</sup> / <sub>8</sub> "	4 <sup>3</sup> / <sub>4</sub> "	5"	3 <sup>3</sup> / <sub>4</sub> "	2 <sup>5</sup> / <sub>8</sub> "	2 <sup>5</sup> / <sub>8</sub> "	5 <sup>1</sup> / <sub>32</sub> "
100/150	4"	4"	1 <sup>1</sup> / <sub>4</sub> "	5"	5 <sup>1</sup> / <sub>4</sub> "	5 <sup>1</sup> / <sub>4</sub> "	4 <sup>1</sup> / <sub>8</sub> "	3 <sup>3</sup> / <sub>8</sub> "	3 <sup>3</sup> / <sub>8</sub> "	5 <sup>1</sup> / <sub>32</sub> "
200/270	5 <sup>1</sup> / <sub>8</sub> "	5 <sup>1</sup> / <sub>8</sub> "	1 <sup>3</sup> / <sub>4</sub> "	6 <sup>1</sup> / <sub>8</sub> "	6 <sup>1</sup> / <sub>8</sub> "	7 <sup>1</sup> / <sub>8</sub> "	5 <sup>1</sup> / <sub>4</sub> "	4 <sup>1</sup> / <sub>8</sub> "	4 <sup>1</sup> / <sub>8</sub> "	1 <sup>1</sup> / <sub>32</sub> "

## J-Line™ Interconnection Systems

Power & High Voltage — Russellstoll® Pin & Sleeve Power Connectors

### Panel Mount Series

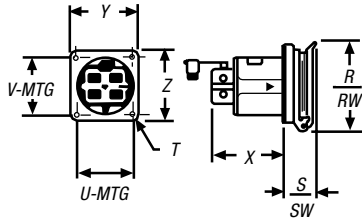

### Standard Series JRFA/JRSA

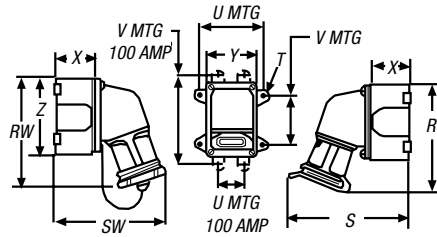

### Series JRFR/JRSR

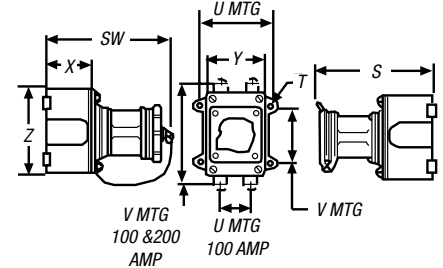

### Series JRFB/JRSB

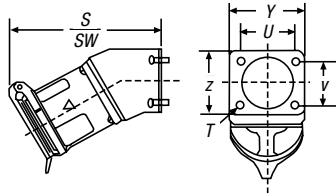

### Series JRFE/JRSE

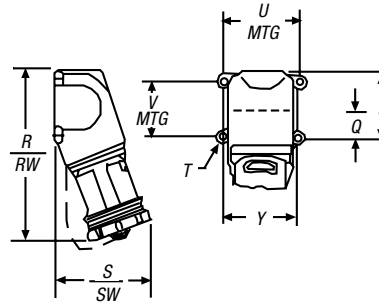

### Series JRFH/HRSH

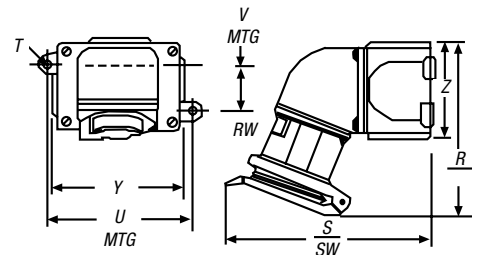

AMP	SERIES	WEATHERTIGHT											PANEL OPENING	
		Z	Y	X	S	SW	R*	RW†	Q	P	V	U		T
30	Panel Mount	3½"	3½"	2⅞"	1¾"	2"	4¼"	3"	—	—	2⅞"	2⅞"	¼"	2¾"
	Standard (20°)	4½"	3"	2½"	7"	6½"	6¾"	6¾"	—	—	2⅞"	3⅞"	¼"	—
	JRFR/JRSR	4½"	3"	2½"	6½"	6½"	—	—	—	—	2⅞"	3⅞"	¼"	—
	JRFB/JRSB	3⅞"	3⅞"	—	5¾"	5¾"	—	—	—	—	2¼"	2¼"	¼"	2¼"
	JRFE/JRSE	—	3½"	—	5¼"	4⅞"	7⅞"	7⅞"	1¼"	2⅞"	—	4	¼"	—
60	Panel Mount	4"	4"	3⅞"	1¾"	2"	5"	3¾"	—	—	3⅞"	3⅞"	⅝"	3¼"
	Standard (20°)	5⅞"	4"	3"	9¼"	8⅞"	8⅞"	9"	—	—	3⅞"	4⅞"	1⅝"	—
	JRFR/JRSR	5⅞"	4"	3"	8⅞"	8½"	—	—	—	—	3⅞"	4⅞"	1⅝"	—
	JRFB/JRSB	3⅞"	3⅞"	—	7⅞"	7⅞"	—	—	—	—	2⅞"	2⅞"	⅝"	2½"
100/150	Panel Mount	4¼"	4¼"	4⅞"	1¾"	2"	5¼"	4⅞"	—	—	3⅞"	3⅞"	⅝"	3½"
	Standard (20°)	5½"	5½"	3½"	10½"	9⅞"	9⅞"	9¾"	—	—	6¼"	4¼"	1⅝"	—
	JRFR/JRSR	5½"	5½"	3½"	11¼"	11⅞"	—	—	—	—	6¼"	4¼"	1⅝"	—
200/270	Panel Mount	6"	6"	5⅞"	2"	2½"	7⅞"	5¼"	—	—	5¼"	5¼"	1⅝"	5⅞"
	Standard (20°)	8⅞"	8⅞"	6⅞"	15⅞"	15⅞"	12⅞"	12⅞"	—	—	9⅞"	7⅞"	⅝"	—
	JRFR/JRSR	8⅞"	8⅞"	6⅞"	15"	15½"	—	—	—	—	9⅞"	7⅞"	⅝"	—
	JRFB/JRSB	4"	4"	—	12¼"	12¼"	—	—	—	—	2¾"	2¾"	1⅝"	—

Note: U = horizontal mounting hole centers; V = vertical mounting hole centers.

\* = Flap Cap.

† = Screen Cap.